

Model ETUF series | Ultrafiltration Module

FEATURES

- Hydrophilic membrane material with high permeability
- Exceptional membrane mechanical strength
- Excellent chemical resistance and tolerance
- Long service life

APPLICATIONS

- Ground/ Well and Surface Water Treatment
- Desalination
- RO Pre-treatment
- Municipal/ Tap Water Purification
- Municipal & Industrial Wastewater Recycling



TECHNICAL SPECIFICATIONS

Membrane

Feature	UOM	Specification
Material	-	Polyvinylidene Fluoride (PVDF)
Pore Size	µm	0.025
Outer/ Inner Diameter	mm	1.30/ 0.70
pH Tolerance (Operation/ Cleaning)	-	2 – 11/ 1 – 12
Temperature Tolerance	°C	5 – 40
Bacteria Removal	LRV	6
Tensile Load	N	5

Module

Feature	UOM	Specification
Overall Dimension (Diameter x Length)	mm	344 x 1,600
Membrane Area	m ²	45
Feed Connection Size (Type)	inch	1.5 (FNPT)
Concentrate Connection Size (Type)	inch	1.5 (FNPT)
Filtrate Connection Size (Type)	inch	1.5 (FNPT)
Dry/ Wet Weight	kg	50/ 90
Potting Material	-	Epoxy/ PU

Operational Information

Feature	UOM	Specification
Filtration Mode	-	Outside-In
Operation Mode	-	Cross-Flow/ Dead-End
Max Feed Pressure	kPa	300
Max Transmembrane Pressure	kPa	150
Max Backwash Pressure	kPa	100
Typical Flux Rates	LMH	60 – 120*
Physical Cleaning Frequency	mins	30 – 120*
Chemical Cleaning Frequency	days	5 – 30*

* Depending on water quality and on-site conditions.

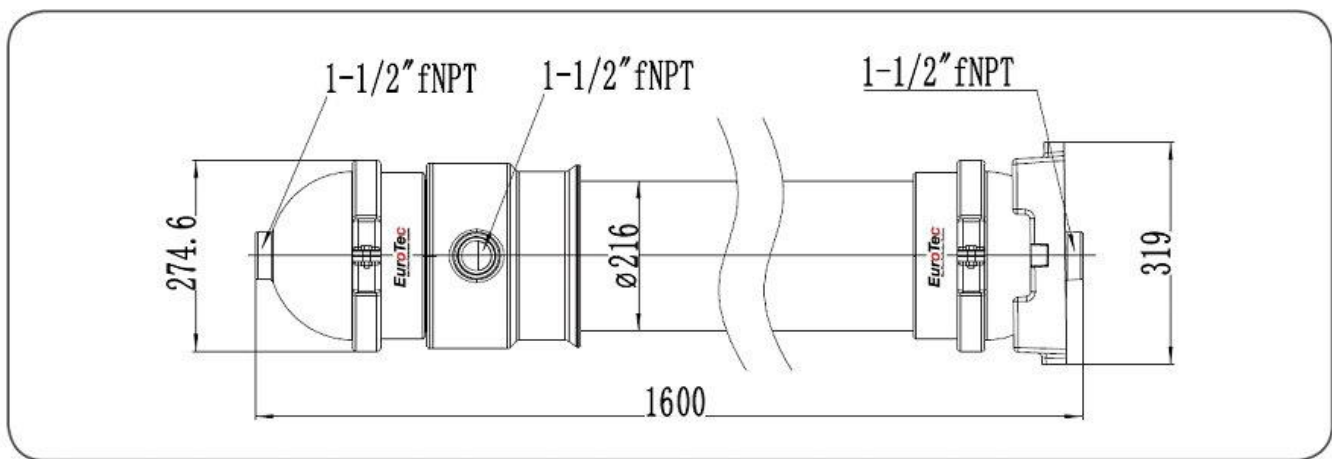

Module Parts

Item No.	Part No.	Item Name	Material
1	ETUF-9045R-01	End Cap	uPVC
2	ETUF-9045R-02	End Cap Clamps	POM
3	ETUF-9045R-03	Housing	uPVC
4	ETUF-9045F-04	Concentrate Chamber	uPVC
5	ETUF-9045F-05	Locating Base	ABS
6	ETUF-9045F-06	End Cap O-Rings	EPDM



No.10 Qingdao Road
 Haping Rd. Centralized Ind'l Park
 Harbin Development Zone
 Harbin 150060, P.R. China
TEL +86 451 8651 6886
FAX +86 451 8651 6661
EMAIL sales@firstline.com.cn



Harbin Firstline Environment Technology Co., Ltd. [First Line] reserves the right to modify the design and specification contained herein without prior notice. Please contact your local First Line sales representative for the most current information.